

Hitch Guard

Unique, patented design

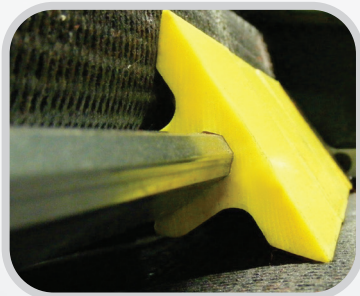

Easy to install: Mount the Hitch Guard to your conveyor with simple brackets and hardware, then install segments with a light mallet tap.



Snap-fit design: The 3" segments are designed to release under pressure if small objects become lodged between belt and segments.

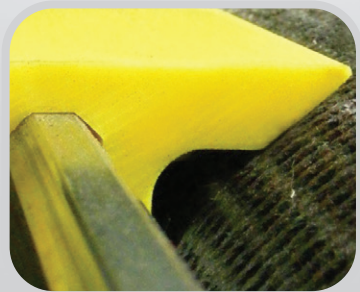

Protection and Safety: UHMW plastic segments have a beveled design that prevents progressive belt damage and reduces pinch points.

The Hitch Guard from Flexco is engineered to provide a smooth transition of product, increasing safety at the conveyor hitch and reducing pinch hazards at the transfer point. The Hitch Guard prevents small objects from becoming lodged in the hitch which can cause longitudinal conveyor belt tears, damage to conveyed products, and costly periods of unscheduled downtime. Designed to permit individual segments to release from the support bar, objects are quickly dislodged while remaining segments stay secured for continued operation.

Choose from a Universal Mounting System that fits most applications or a Scanner Eye Mounting System that doesn't interfere with electronic scanner eyes, but still keeps hitch protected.

Each Hitch Guard comes with a specially designed gauge for proper positioning in the hitch allowing for optimal installation and performance. See Hitch Guard Installation Specifications chart below to determine if the Flexco Hitch Guard is appropriate for your conveyor hitch.

Hitch Guard Installation Specifications									
Pulley Diameter (inches) (including belt)	2.5	3.0	3.5	4.0	4.5	5.0	5.5	6.0	6.5
Minimum Gap Required (inches)	0.8	0.5	0.1	0	0	0	0	0	0
Maximum Gap (inches)	1.6	1.4	1.2	1.0	0.8	0.6	0.4	0.2	0

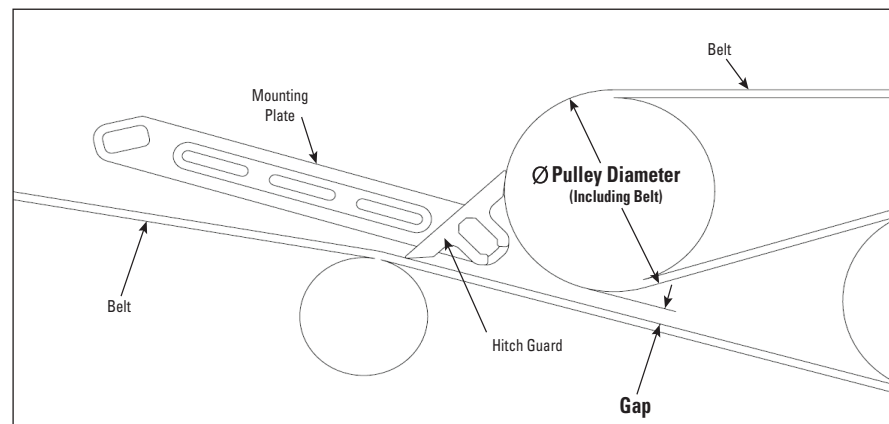

Hitch Guard Ordering Information					
Maximum Conveyor Width	Universal Mounting Bracket		Scanner Eye Mounting Bracket		Item Code
	Ordering Number	Item Code	Ordering Number	Item Code	
36"	900	HITCHGD-V3-KIT-36IN	04442	HITCHGD-V1-KIT-36IN	04322
42"	1050	HITCHGD-V3-KIT-42IN	04443	HITCHGD-V1-KIT-42IN	04321
48"	1200	HITCHGD-V3-KIT-48IN	04444	HITCHGD-V1-KIT-48IN	04320
60"	1500	HITCHGD-V3-KIT-60IN	04445	HITCHGD-V1-KIT-60IN	04319
72"	1800	HITCHGD-V3-KIT-72IN	04988	HITCHGD-V1-KIT-72IN	04973

ISO 9000
2525 Wisconsin Avenue • Downers Grove, IL 60515-4200 • USA
Tel: (630) 971-0150 • Fax: (630) 971-1180 • E-mail: info@flexco.com

Visit www.flexco.com for other Flexco locations and products.

©2017 Flexible Steel Lacing Company. 03-25-22. For reorder: X4210

WBT-173-FLEXCO BROCH_0822

www.weimerbearing.com



Segmented Transfer Plates

Prevent Product Loss and Increase Safety at the Transfer Point

Transferring products safely from one belt to another, from belt to chute, or from belt to structure is often one of the biggest problems for material transfer operations. Segmented Transfer Plates from Flexco can help prevent product loss, increase operator safety, and reduce pinch hazards at the transfer point, preventing potential damage to the product as well as the belt and conveyor structure. Bright yellow segments snap onto the mounting bar to accommodate belts up to 60" (1500 mm) wide and gaps from 4" to 10" (100 mm to 250 mm). A Segmented Transfer Plate design with a narrower support bar is also available for smaller pulley to pulley gaps from 1.5" to 3" (38 mm to 75 mm).

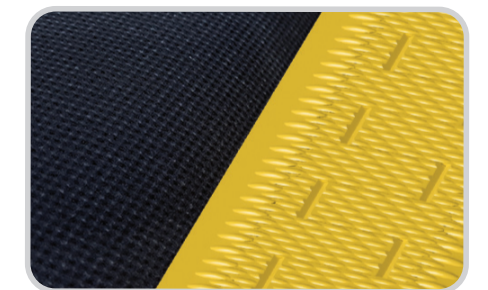

Provides a **smooth transition** at the transfer point.

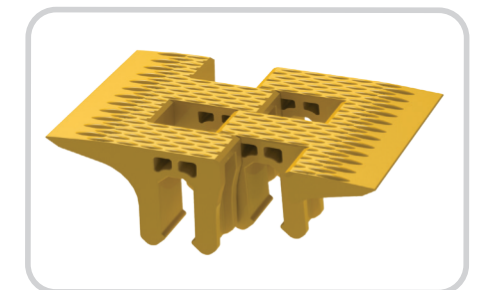

HDPE segments lock together and raised ribs help reduce the surface friction so **product slides easily across the transfer.**

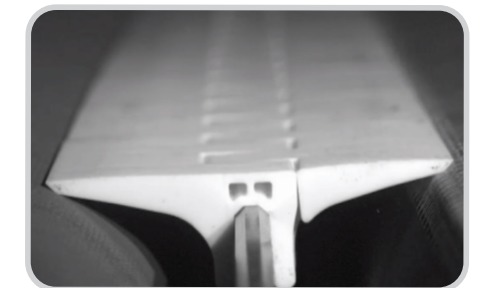

Increase the safety of your conveyor by **reducing pinch points.**

Features and Benefits:

- Bright yellow color makes segments easy to monitor for replacement.
- Compatible with both endless and mechanical belt splices.
- Ideal for package handling and airport applications.
- Precision-molded segments ensure accurate fit and long-term protection of gaps.
- HDPE segments have raised ribs that reduce surface friction and serve as visual wear indicators.
- Beveled plastic segments positioned directly on the belt prevent product ingestion and reduce pinch points.

Patents: www.flexco.com/patents

www.weimerbearing.com



SEGMENTED TRANSFER PLATES

4-10" Gaps

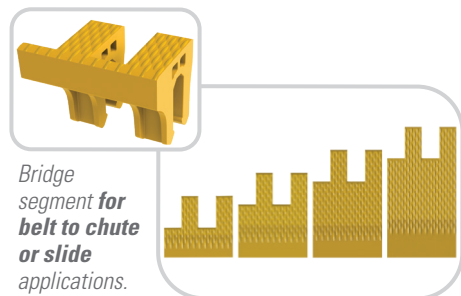

Segments are available in 1 inch increments from 2" to 5" (50 mm to 125 mm) lengths.

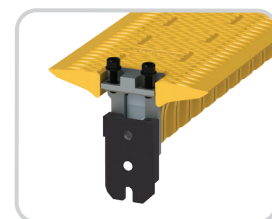
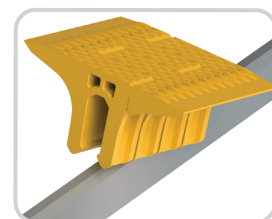

How To Order

1. Specify belt width. Mounting bar is 2" longer than specified belt width.
2. Determine transfer size required.
3. Determine mounting bar location and if offset is required.

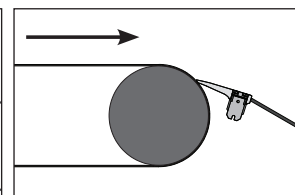
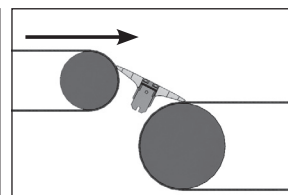
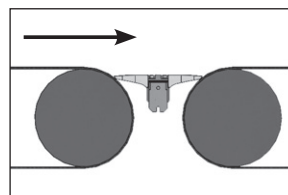

For Horizontal to Horizontal or Waterfall Applications and Gaps from 4" to 10" (100 mm to 250 mm)

Transfer Width	Mounting Bar Offset	Belt Widths										
		24" (610 mm)		36" (914 mm)		42" (1067 mm)		48" (1219 mm)		60" (1524 mm)		
		Item Code	Ordering Number	Item Code	Ordering Number	Item Code	Ordering Number	Item Code	Ordering Number	Item Code	Ordering Number	
4"	102	none	56100	TGB-4/102-2/2-24/610	56101	TGB-4/102-2/2-36/914	56181	TGB-4/102-2/2-42/1067	56102	TGB-4/102-2/2-48/1219	56103	TGB-4/102-2/2-60/1524
5"	127	0.5"	56104	TGB-5/127-2/3-24/610	56105	TGB-5/127-2/3-36/914	56182	TGB-5/127-2/3-42/1067	56106	TGB-5/127-2/3-48/1219	56107	TGB-5/127-2/3-60/1524
6"	152	1.0"	56108	TGB-6/152-2/4-24/610	56109	TGB-6/152-2/4-36/914	56183	TGB-6/152-2/4-42/1067	56110	TGB-6/152-2/4-48/1219	56111	TGB-6/152-2/4-60/1524
		none	56112	TGB-6/152-3/3-24/610	56113	TGB-6/152-3/3-36/914	56184	TGB-6/152-3/3-42/1067	56114	TGB-6/152-3/3-48/1219	56115	TGB-6/152-3/3-60/1524
7"	178	1.5"	56116	TGB-7/178-2/5-24/610	56117	TGB-7/178-2/5-36/914	56185	TGB-7/178-2/5-42/1067	56118	TGB-7/178-2/5-48/1219	56119	TGB-7/178-2/5-60/1524
		0.5"	56120	TGB-7/178-3/4-24/610	56121	TGB-7/178-3/4-36/914	56186	TGB-7/178-3/4-42/1067	56122	TGB-7/178-3/4-48/1219	56123	TGB-7/178-3/4-60/1524
8"	203	1.0"	56128	TGB-8/203-3/5-24/610	56129	TGB-8/203-3/5-36/914	56187	TGB-8/203-3/5-42/1067	56130	TGB-8/203-3/5-48/1219	56131	TGB-8/203-3/5-60/1524
		none	56132	TGB-8/203-4/4-24/610	56133	TGB-8/203-4/4-36/914	56188	TGB-8/203-4/4-42/1067	56134	TGB-8/203-4/4-48/1219	56135	TGB-8/203-4/4-60/1524
9"	229	0.5"	56140	TGB-9/229-4/5-24/610	56141	TGB-9/229-4/5-36/914	56189	TGB-9/229-4/5-42/1067	56142	TGB-9/229-4/5-48/1219	56143	TGB-9/229-4/5-60/1524
10"	254	none	56148	TGB-10/254-5/5-24/610	56149	TGB-10/254-5/5-36/914	56190	TGB-10/254-5/5-42/1067	56150	TGB-10/254-5/5-48/1219	56151	TGB-10/254-5/5-60/1524

For Belt to Chute or Slide Applications and Gaps from 3" to 6" (75 mm to 150 mm)

Transfer Width	Mounting Bar Offset	Belt Widths										
		24" (610 mm)		36" (914 mm)		42" (1067 mm)		48" (1219 mm)		60" (1524 mm)		
		Item Code	Ordering Number	Item Code	Ordering Number	Item Code	Ordering Number	Item Code	Ordering Number	Item Code	Ordering Number	
3"	76	0.5"	56206	TGB-3/76-2/B-24/610	56207	TGB-3/76-2/B-36/914	56208	TGB-3/76-2/B-42/1067	56209	TGB-3/76-2/B-48/1219	56210	TGB-3/76-2/B-60/1524
4"	102	1.0"	56211	TGB-4/102-3/B-24/610	56212	TGB-4/102-3/B-36/914	56213	TGB-4/102-3/B-42/1067	56214	TGB-4/102-3/B-48/1219	56215	TGB-4/102-3/B-60/1524
5"	127	1.5"	56216	TGB-5/127-4/B-24/610	56217	TGB-5/127-4/B-36/914	56218	TGB-5/127-4/B-42/1067	56219	TGB-5/127-4/B-48/1219	56220	TGB-5/127-4/B-60/1524
6"	152	2.0"	56221	TGB-6/152-5/B-24/610	56222	TGB-6/152-5/B-36/914	56223	TGB-6/152-5/B-42/1067	56224	TGB-6/152-5/B-48/1219	56225	TGB-6/152-5/B-60/1524

SEGMENTED TRANSFER PLATES

1.5 to 3" Gaps

A Segmented Transfer Plate option is available for narrower gaps from 1.5" to 3" (38 mm to 75 mm).



Combinations of paired segments lock together inside the support bar to create the span required for the application.



Raised Ribs help reduce the surface friction on the shorter transitions – especially important for the consistency in metered spacing when lighter parcels and packages are being conveyed.



Easy to configure mounting plates provide flexibility in installation options.



How To Order

1. Specify belt width. Mounting bar is 2" longer than specified belt width.
2. Determine transfer size required.
3. Determine mounting bar location.
4. Segmented Transfer Plate 1.5" to 3" gaps are not recommended for belt to chute/slide applications.

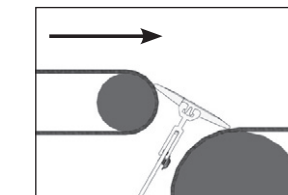
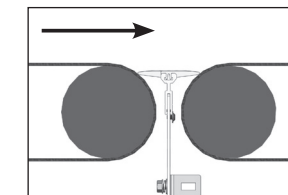

For Horizontal to Horizontal or Waterfall Applications and Gaps from 1.5" to 3" (38 mm to 75 mm)

Transfer Width	Mounting Bar Offset	Belt Widths						
		24" (610 mm)		36" (914 mm)		42" (1067 mm)		
		Item Code	Ordering Number	Item Code	Ordering Number	Item Code	Ordering Number	
1.5"	38	none	56227	TGB-1.5/38-.75/.75-24/610	56228	TGB-1.5/38-.75/.75-36/914	56229	TGB-1.5/38-.75/.75-42/1067
1.75"	44	0.125"	56232	TGB-1.75/44-1/.75-24/610	56233	TGB-1.75/44-1/.75-36/914	56234	TGB-1.75/44-1/.75-42/1067
2.0"	51	none	56237	TGB-2/51-1/1-24/610	56238	TGB-2/51-1/1-36/914	56239	TGB-2/51-1/1-42/1067
2.25"	57	0.375"	56242	TGB-2.25/57-1.5/.75-24/610	56243	TGB-2.25/57-1.5/.75-36/914	56244	TGB-2.25/57-1.5/.75-42/1067
2.5"	64	.250"	56247	TGB-2.5/64-1.5/1-24/610	56248	TGB-2.5/64-1.5/1-36/914	56249	TGB-2.5/64-1.5/1-42/1067
3.0"	76	none	56252	TGB-3/76-1.5/1.5-24/610	56253	TGB-3/76-1.5/1.5-36/914	56254	TGB-3/76-1.5/1.5-42/1067

For Horizontal to Horizontal or Waterfall Applications and Gaps from 1.5" to 3" (38 mm to 75 mm)

Transfer Width	Mounting Bar Offset	Belt Widths				
		48" (1219 mm)		60" (1524 mm)		
		Item Code	Ordering Number	Item Code	Ordering Number	
1.5"	38	none	56230	TGB-1.5/38-.75/.75-48/1219	56231	TGB-1.5/38-.75/.75-60/1524
1.75"	44	0.125"	56235	TGB-1.75/44-1/.75-48/1219	56236	TGB-1.75/44-1/.75-60/1524
2.0"	51	none	56240	TGB-2/51-1/1-48/1219	56241	TGB-2/51-1/1-60/1524
2.25"	57	0.375"	56245	TGB-2.25/57-1.5/.75-48/1219	56246	TGB-2.25/57-1.5/.75-60/1524
2.5"	64	.250"	56250	TGB-2.5/64-1.5/1-48/1219	56251	TGB-2.5/64-1.5/1-60/1524
3.0"	76	none	56255	TGB-3/76-1.5/1.5-48/1219	56256	TGB-3/76-1.5/1.5-60/1524